

# LH538700A

**PRELIMINARY**  
**CMOS 8M (1M × 8) MROM**

## FEATURES

- 1,048,576 words × 8 bit organization
- Access time: 100 ns (MAX.)
- Power consumption:
  - Operating: 550 mW (MAX.)
  - Standby: 550 μW (MAX.)
- Static operation
- TTL compatible I/O
- Three-state outputs
- Single +5 V power supply
- Packages:
  - 32-pin, 600-mil DIP
  - 32-pin, 525-mil SOP
  - 32-pin, 400-mil TSOP (Type II)

## DESCRIPTION

The LH538700A is an 8M-bit mask-programmable ROM organized as 1,048,576 × 8 bits. It is fabricated using silicon-gate CMOS process technology.

## PIN CONNECTIONS

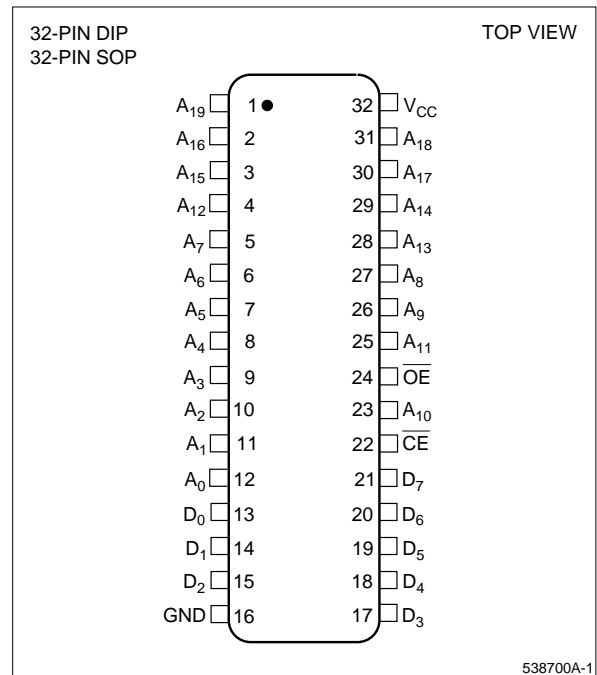

Figure 1. Pin Connections for DIP and SOP Packages

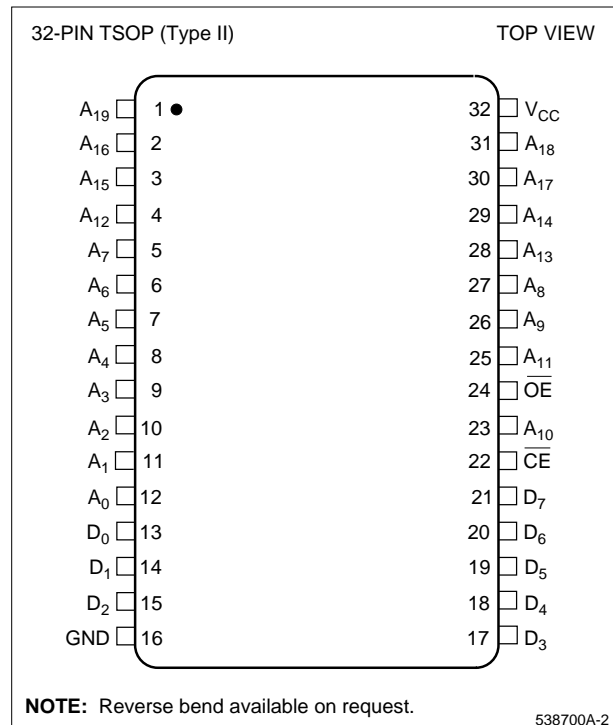
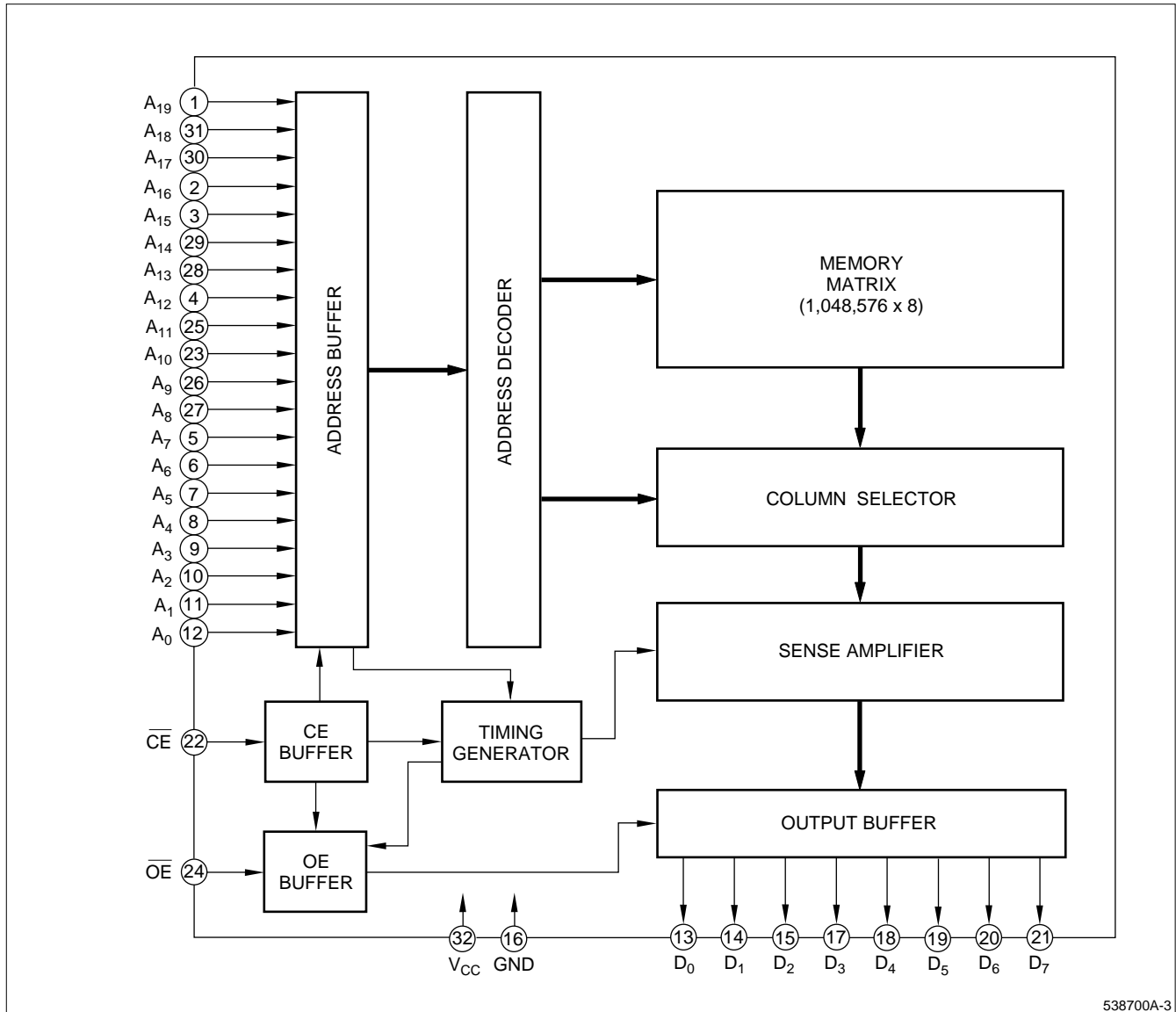

Figure 2. Pin Connections for TSOP Package



538700A-3

Figure 3. LH538700A Block Diagram

**PIN DESCRIPTION**

SIGNAL	PIN NAME
A <sub>0</sub> – A <sub>19</sub>	Address input
D <sub>0</sub> – D <sub>7</sub>	Data output
CE	Chip enable input

SIGNAL	PIN NAME
OE	Output enable input
V <sub>CC</sub>	Power supply (+5 V)
GND	Ground

## TRUTH TABLE

$\overline{CE}$	$\overline{OE}$	DATA OUTPUT	SUPPLY CURRENT
H	X	High-Z	Standby
L	H	High-Z	Operating
L	L	Output	Operating

## NOTE:

X = H or L.

## ABSOLUTE MAXIMUM RATINGS

PARAMETER	SYMBOL	RATING	UNIT
Supply voltage	$V_{CC}$	-0.3 to +7.0	V
Input voltage	$V_{IN}$	-0.3 to $V_{CC} + 0.3$	V
Output voltage	$V_{OUT}$	-0.3 to $V_{CC} + 0.3$	V
Operating temperature	$T_{opr}$	0 to +70	°C
Storage temperature	$T_{stg}$	-65 to +150	°C

RECOMMENDED OPERATING CONDITIONS ( $T_A = 0^\circ\text{C}$  to  $+70^\circ\text{C}$ )

PARAMETER	SYMBOL	MIN.	TYP.	MAX.	UNIT
Supply voltage	$V_{CC}$	4.5	5.0	5.5	V

DC CHARACTERISTICS ( $V_{CC} = 5\text{ V} \pm 10\%$ ,  $T_A = 0^\circ\text{C}$  to  $+70^\circ\text{C}$ )

PARAMETER	SYMBOL	CONDITIONS	MIN.	MAX.	UNIT	NOTE
Input 'Low' voltage	$V_{IL}$		-0.3	0.8	V	
Input 'High' voltage	$V_{IH}$		2.2	$V_{CC} + 0.3$	V	
Output 'Low' voltage	$V_{OL}$	$I_{OL} = 2.0\text{ mA}$		0.4	V	
Output 'High' voltage	$V_{OH}$	$I_{OH} = -400\ \mu\text{A}$	2.4		V	
Input leakage current	$ I_{LI} $	$V_{IN} = 0\text{ V to } V_{CC}$		10	$\mu\text{A}$	
Output leakage current	$ I_{LO} $	$V_{OUT} = 0\text{ V to } V_{CC}$		10	$\mu\text{A}$	1
Operating current	$I_{CC1}$	$t_{RC} = 100\text{ ns}$		100	mA	2
	$I_{CC2}$	$t_{RC} = 1\ \mu\text{s}$		90	mA	2
Standby current	$I_{SB1}$	$\overline{CE} = V_{IH}$		3	mA	
	$I_{SB2}$	$\overline{CE} = V_{CC} - 0.2\text{ V}$		100	$\mu\text{A}$	
Input capacitance	$C_{IN}$	$f = 1\text{ MHz}$		10	pF	
Output capacitance	$C_{OUT}$	$T_A = 25^\circ\text{C}$		10	pF	

## NOTES:

- $\overline{CE}/\overline{OE} = V_{IH}$
- $V_{IN} = V_{IH}$  or  $V_{IL}$ ,  $\overline{CE} = V_{IL}$ , outputs open

## AC CHARACTERISTICS ( $V_{CC} = 5\text{ V} \pm 10\%$ , $T_A = 0^\circ\text{C}$ to $+70^\circ\text{C}$ )

PARAMETER	SYMBOL	MIN.	MAX.	UNIT	NOTE
Read cycle time	$t_{RC}$	100		ns	
Address access time	$t_{AA}$		100	ns	
Chip enable access time	$t_{ACE}$		100	ns	
Output enable delay time	$t_{OE}$		50	ns	
Output hold time	$t_{OH}$	5		ns	
CE to output in High-Z	$t_{CHZ}$		40	ns	1
OE to output in High-Z	$t_{OHZ}$		40	ns	1

### NOTE:

1. This is the time required for the output to become high-impedance.

## AC TEST CONDITIONS

PARAMETER	RATING
Input voltage amplitude	0.4 V to 2.6 V
Input rise/fall time	10 ns
Input/output reference level	1.5 V
Output load condition	1TTL + 100 pF

## CAUTION

To stabilize the power supply, it is recommended that a high-frequency bypass capacitor be connected between the  $V_{CC}$  pin and the GND pin.

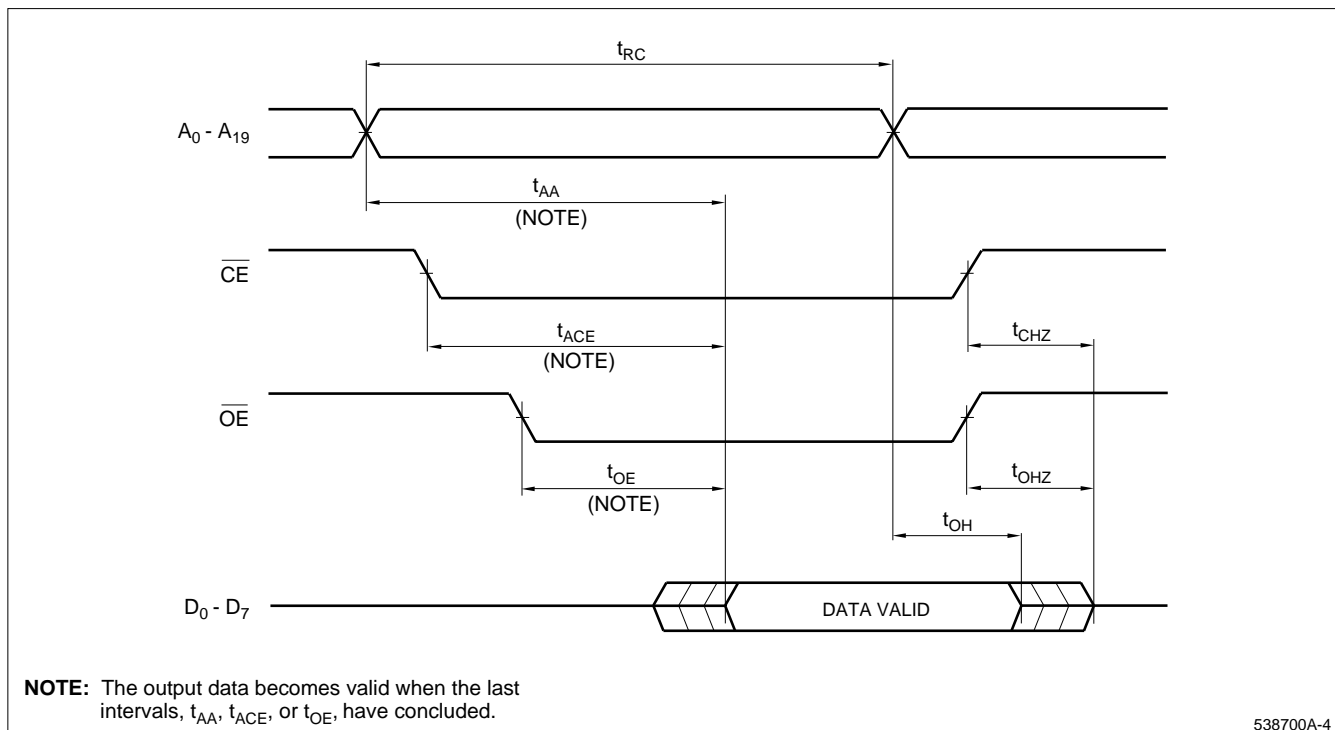
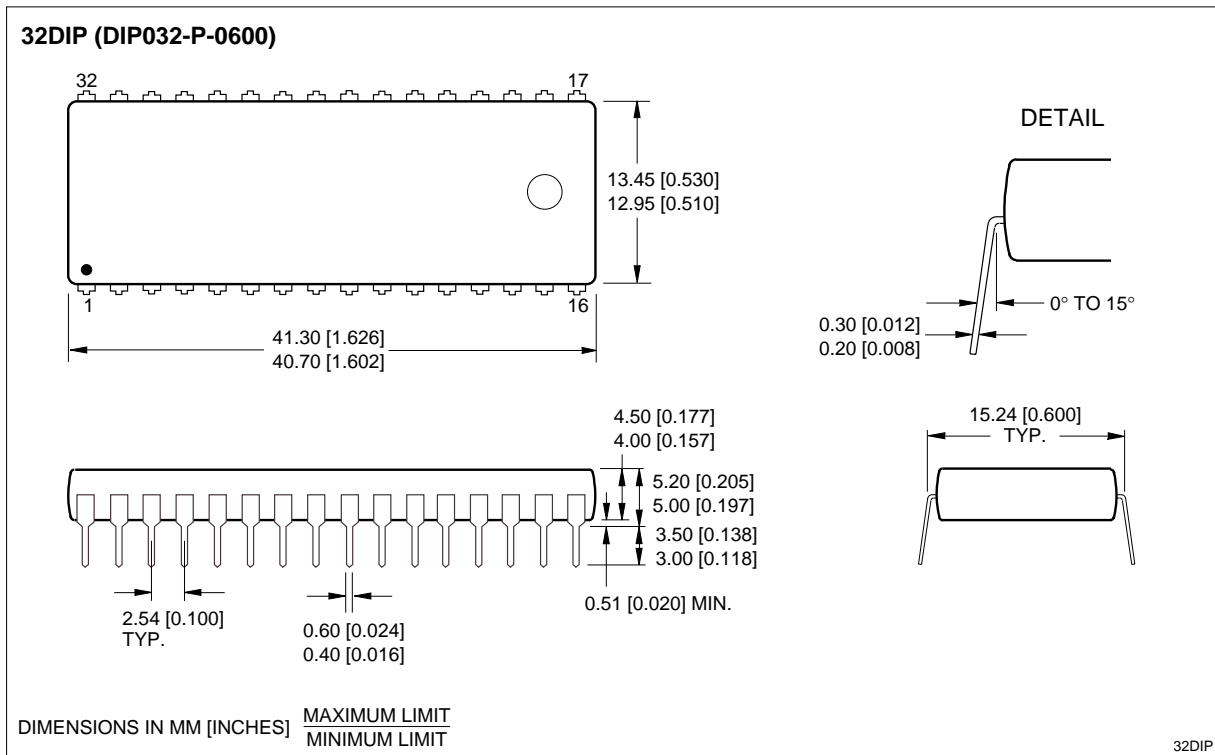
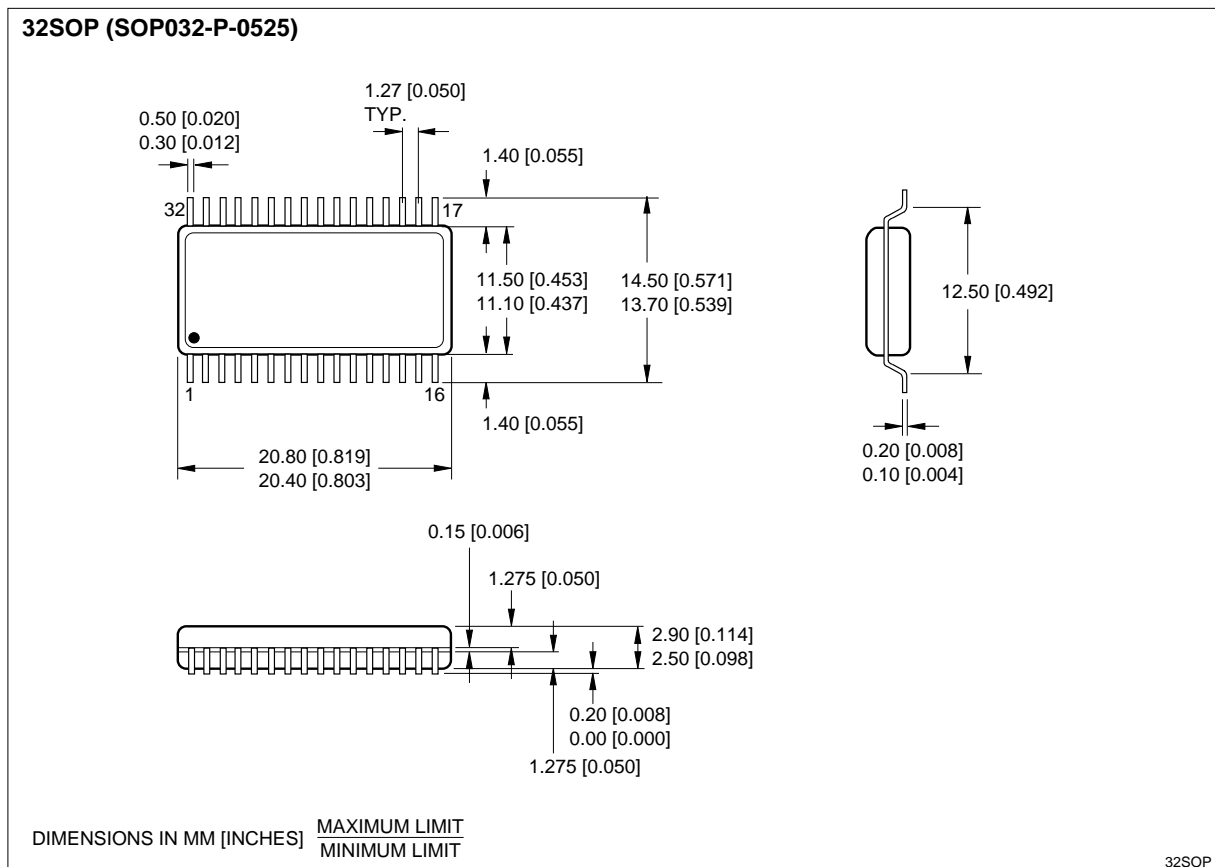

Figure 4. Timing Diagram

PACKAGE DIAGRAMS



32-pin, 600-mil DIP



32-pin, 525-mil SOP

32TSOP (Type II) (TSOP032-P-0400)

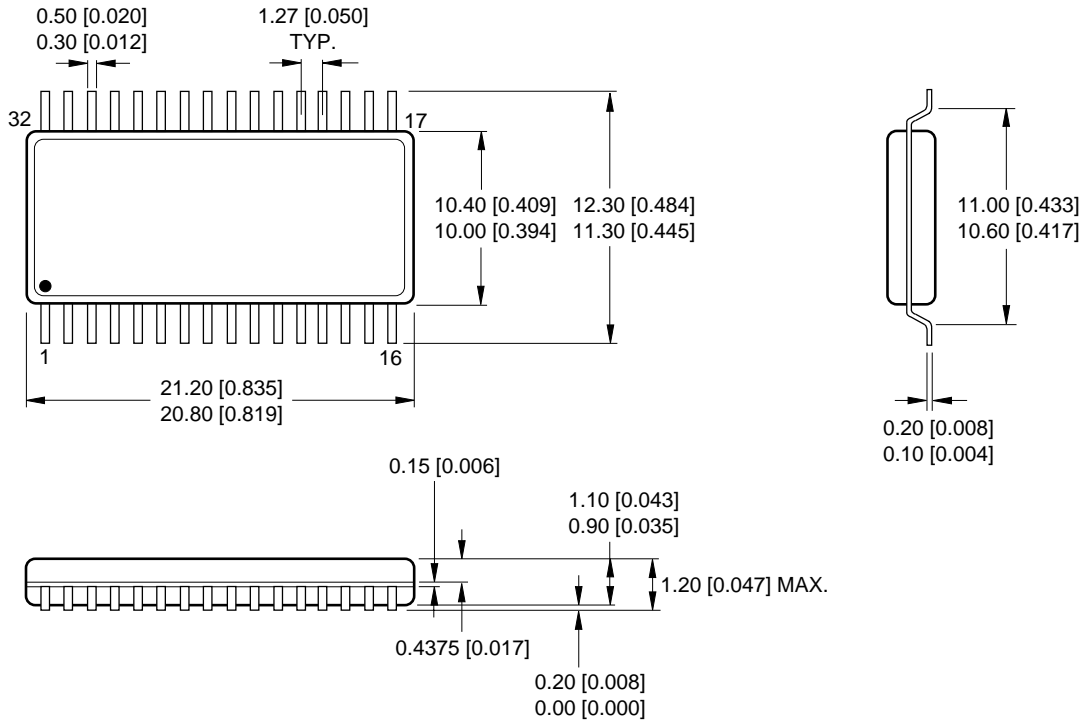

DIMENSIONS IN MM [INCHES]    MAXIMUM LIMIT  
   MINIMUM LIMIT

32TSOP400

32-pin, 400-mil TSOP (Type II)

ORDERING INFORMATION

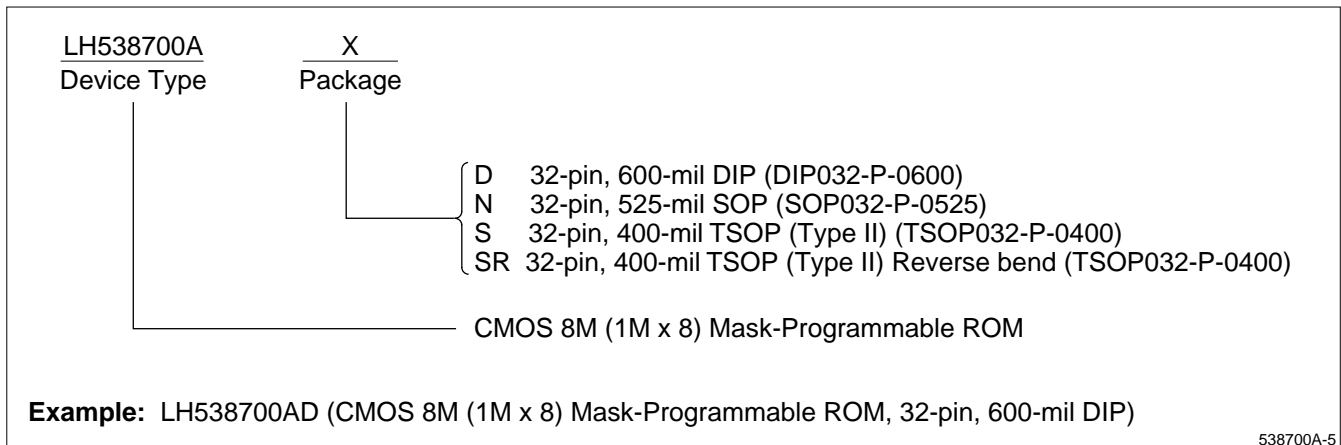

538700A-5